

# PETKIT

## USER MANUAL

PETKIT PURA MAX SELF-CLEANING CAT LITTER BOX

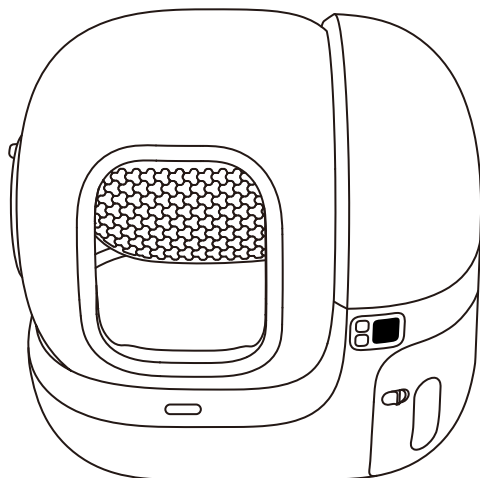

Please read the User Manual carefully before using the product and keep it properly.

V1.2-3/2024

# TABLE OF CONTENTS

<b>PRODUCT LIST</b>	<b>3</b>
<b>PRODUCT DESCRIPTION</b>	<b>4</b>
<b>PRODUCT INSTALLATION</b>	<b>5</b>
<b>HOW TO USE</b>	<b>8</b>
<b>CLEANING AND MAINTENANCE</b>	<b>17</b>
<b>VIDEO GUIDE</b>	<b>23</b>
<b>BASIC SPECIFICATIONS</b>	<b>24</b>
<b>A MESSAGE TO OUR VALUED CUSTOMERS</b>	<b>24</b>
<b>USER SAFETY GUIDE</b>	<b>25</b>

# 01 PRODUCT LIST

\*Please ensure that all accessories are present before installation and use.

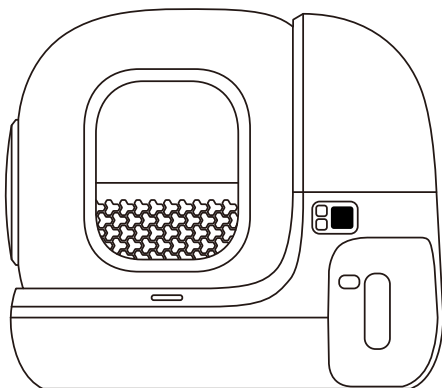

Main Unit

## Accessories

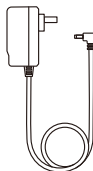

Power Adapter



Trash Bag



Odor Eliminator N50

\* N50 Pet Odor Eliminator is not included in some versions

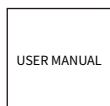

User Manual

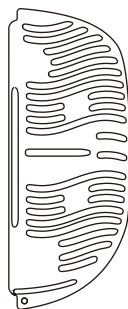

Cat Litter Remover

# 02 PRODUCT DESCRIPTION

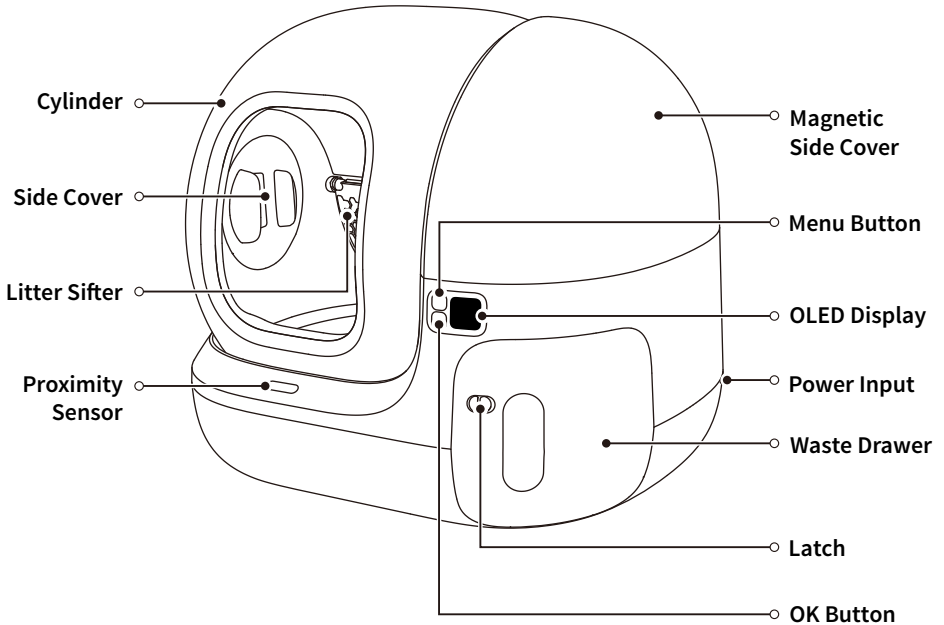

\*Note: In order to provide the best experience possible, we periodically update our products with various improvements. The actual product may vary from its illustrations on packaging. For any inconsistencies, please refer to the actual product.

# 03 PRODUCT INSTALLATION

## 3.1 Installing Waste Drawer

① Slide the latch to the right and pull out the waste drawer; open its lid to take out accessories.

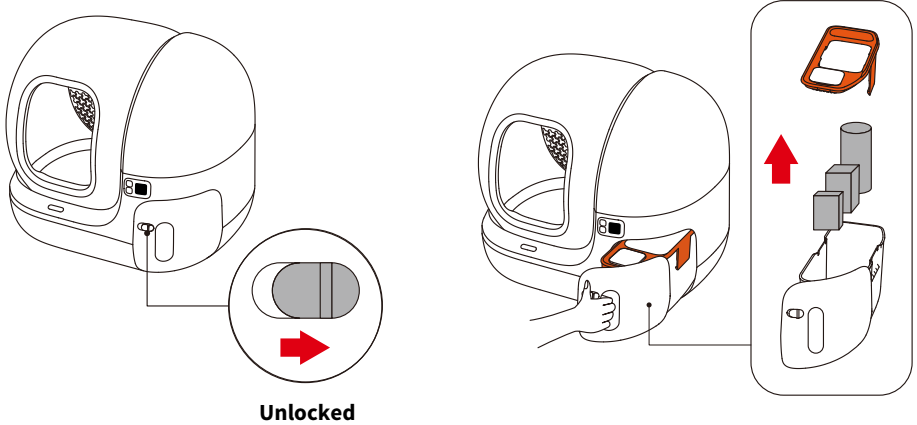

② Spread the trash bag evenly and press it into the bottom of the waste drawer, and close the lid of waste drawer.

**\*Note: The trash bag need to be fastened by the two sides of the lid (as shown in Fig. 1).**

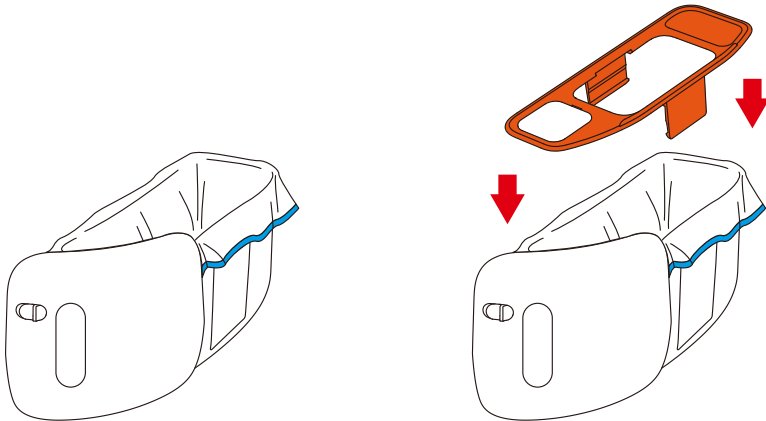
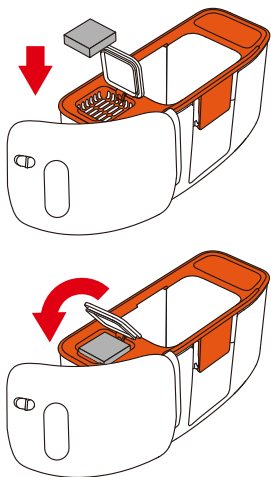
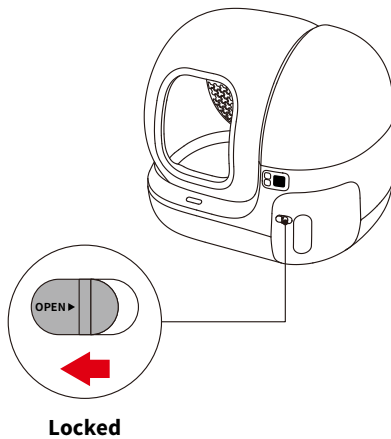

Fig. 1

③ Take out the Odor Eliminator N50 and put it into the groove and press the silicone lid to firmly close.





④ Re-install the waste drawer to the main unit and lock the latch.



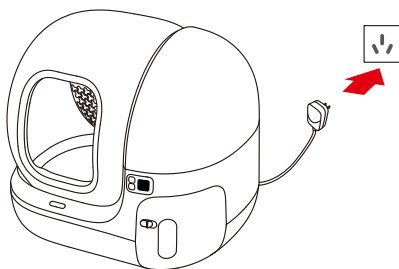
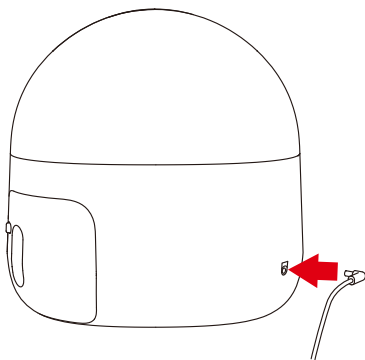

⑤ Take out the power adapter, insert it into the power input on the back of the main unit, and then plug in.

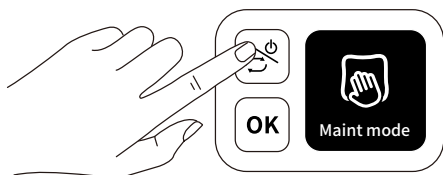

### 3.3 Pouring Cat Litter

① After plugging in and starting up, shortly press  to switch to “Maintenance Mode”. Shortly press  to activate the mode.



② Pour in cat litter when the cylinder opening faces up and stays still, and shortly press  to exit “Maintenance Mode”.

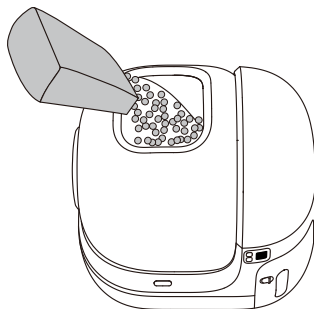

Ensure that the amount of cat litter does not exceed the MAX line. The length of the cat litter selected must be shorter than 1.2cm, and the diameter less than 3mm.

③ Double click  and the device automatically levels off the cat litter.

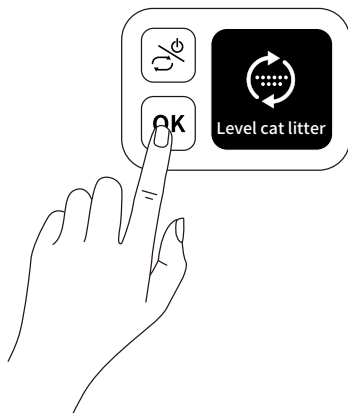

# 04 HOW TO USE



## 4.1 Operating Main Unit

### Button usage



OLED display



- ⦿ Long press  : Turn on/off
- ⦿ Short press  : Switch functions and the screen will display the selected function.
- ⦿ Short press  : Execute the selected function.

### Function Description

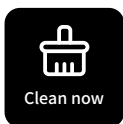

Clean now

Start self-cleaning mode

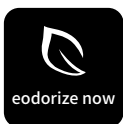

eodorize now

Start to deodorize



Level cat litter

Level the cat litter  
in the cylinder (use when  
daily adding cat litter)



Rest

Reset the cylinder back  
to original position



Maint mode

Use it when adding cat  
litter or cleaning cat litter



figure the netw

Connect to Wi-Fi  
(use when binding the  
device to the App)



## 4.2 Display Indication

### Status Indication

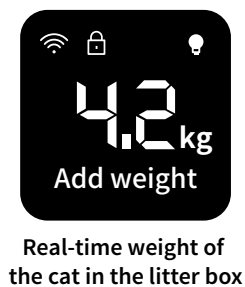
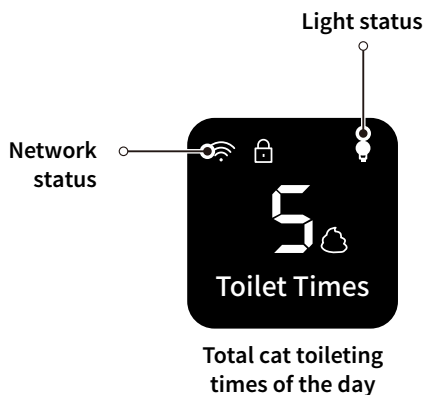

### Fault Indication



Please check whether the air purifier smart spray is installed

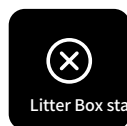

Please turn the cylinder knob on the back of the main unit to the locked position.



The device will automatically pause and alert when a cat approaches or enters the litter box during operation.



Check detailed fault in the App.

## 4.3 App Binding and Activating

① Download and install the App:

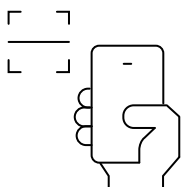

Download “PETKIT” App on the App Store  
or Android Store



② Add the device

Open the downloaded “PETKIT” App and navigate to the home page; Tap the “+” button in the top right corner to add the device. Select “PETKIT PURA MAX SELF-CLEANING CAT LITTER BOX”.



Note: To enhance user experience, occasional software upgrades may occur so that the app interface may vary. Please refer to the actual product.

### ③ Start connection

Tap the Menu button on the device and switch to “Configure network”. Tap the OK button to initiate connection. The screen will display “Connecting...”, and the App will start connecting to the device. Please wait until the configuration is successful.

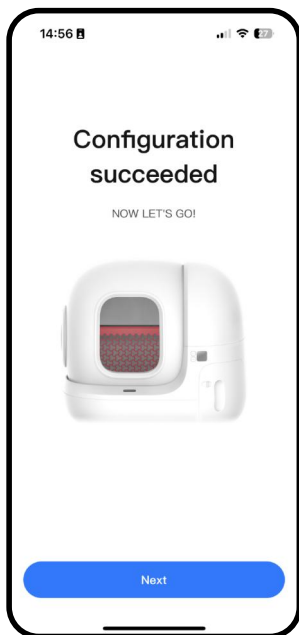
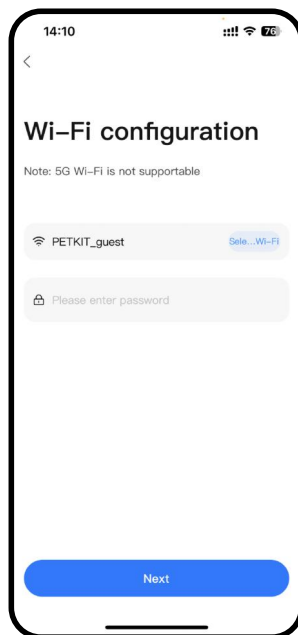
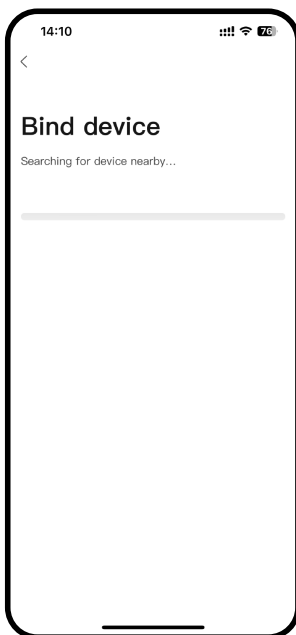
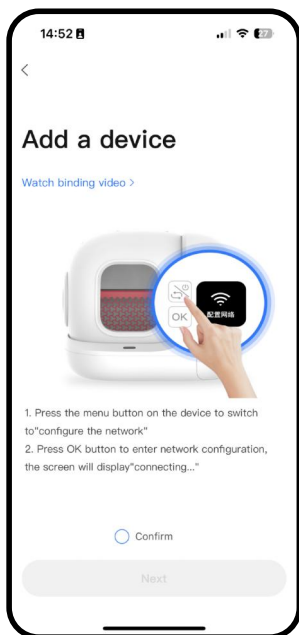

Note: To enhance user experience, occasional software upgrades may occur so that the app interface may vary. Please refer to the actual product.

④ **Read usage guide**

To ensure the safety of your pet and the correct usage of this product, please read the usage guide carefully to use the product properly after successfully connecting it to the App for the first time.

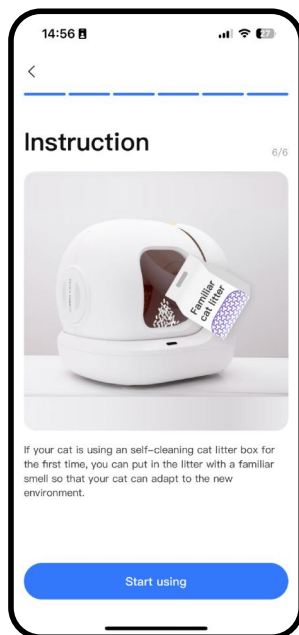
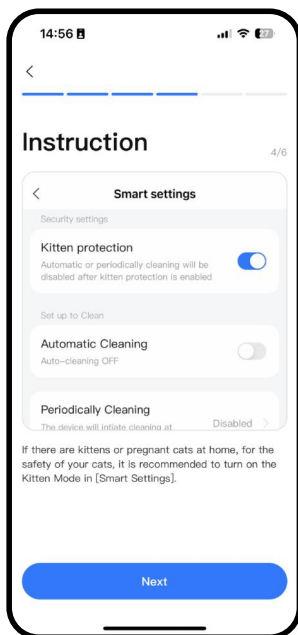
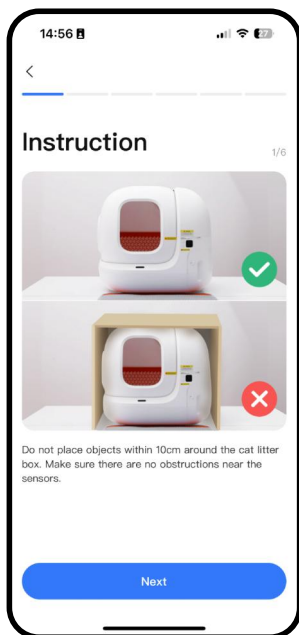

Note: To enhance user experience, occasional software upgrades may occur so that the app interface may vary. Please refer to the actual product.

## 4.4 Smart App Control

### ① Viewing device status

Click “PETKIT PURA MAX” on the device list on the home page to enter the device’s home page and take a look at its working status, toileting times of the day as well as remaining cat litter.

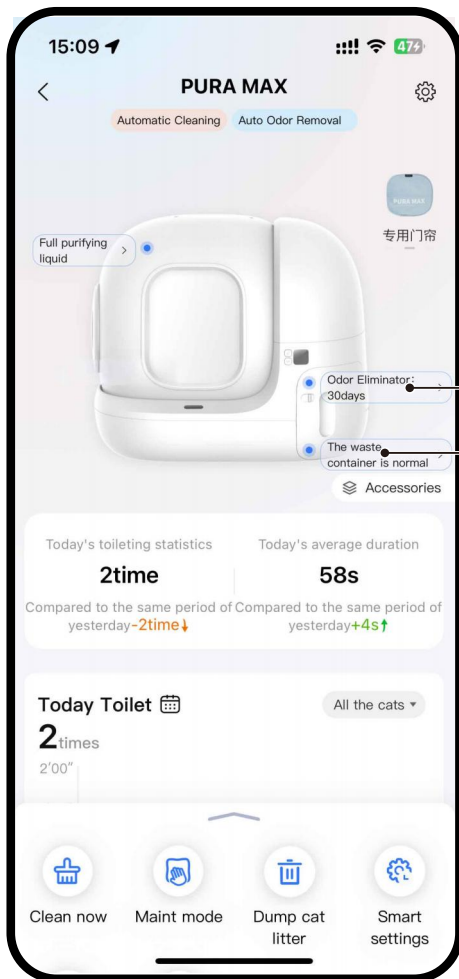

Reminder of the odor eliminator's service life

Reminder of waste container status

Note: To enhance user experience, occasional software upgrades may occur so that the app interface may vary. Please refer to the actual product.

## ② Basic function description



**Clean now:** Click it to clean the litter box after your fur baby finishes toileting.



**Maintenance mode:** Click it to enter the maintenance mode to leave the cylinder opening facing up and staying still to clean the device and add cat litter with ease.



**Empty cat litter:** Click it to empty the remaining cat litter in the cylinder after installing the cat litter remover.



**Smart settings:** Safety and cleaning functions can be set.



**Odor removal now:** Click it to deodorize.



**Light:** Click it to turn on the light to check the conditions of your fur baby or the inside of the cylinder.

**\*PETKIT AIR PURIFIER SMART SPRAY needs to be purchased separately.**

## 4.5 Usage of Air Purifier Smart Spray

Click “Bind Smart Spray” on the home page, or click “SUPER ODOR REMOVAL” in settings to bind PETKIT AIR PURIFIER SMART SPRAY (It needs to be purchased separately).

- ① **Odor removal:** Odor removal is automatically performed after your fur baby toilets to keep air fresh.
- ② **Light:** Light is turned on via app to check the conditions of your fur baby or the inside of the cylinder.

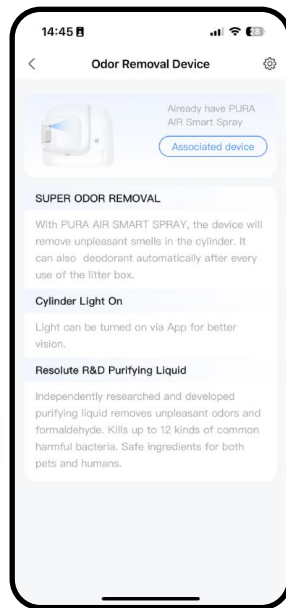
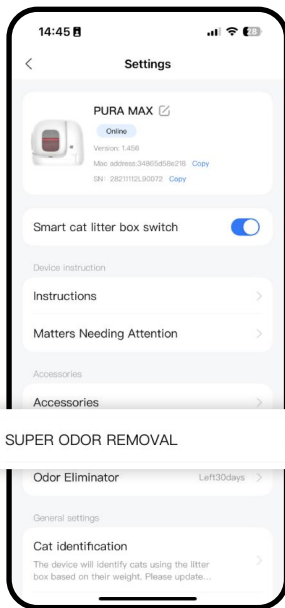
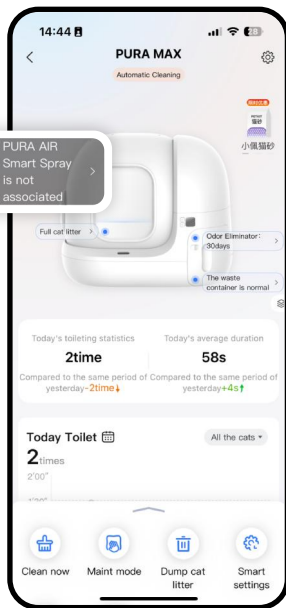

Note: To enhance user experience, occasional software upgrades may occur so that the app interface may vary. Please refer to the actual product.

## 4.6 Other Functions

### ① Kitten mode:

This mode needs to be turned on if you have kittens or pregnant cats at home. When this mode is on, the device will not clean itself periodically or automatically. Waste is collected by clicking “Clean now”.

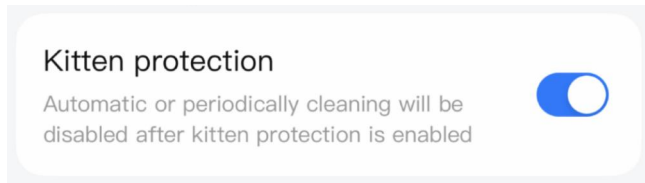

### ② Rotation without interruption

When this function is off, the device will stop working if it senses any cat is approaching. When the opening of the cylinder is facing down, other cats may enter the litter box, resulting in their secretions leaking into the bottom of the device, which makes it harder to clean.

**\*When this function is on, the device will not stop working if it senses any cat is approaching, which may reduce the possibility of cat entering and its secretions leaking into the bottom of the device.**

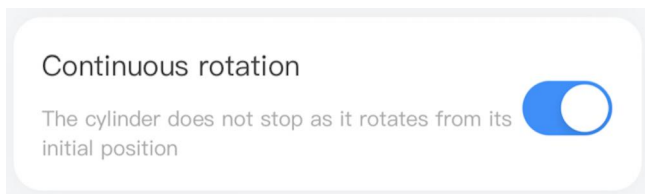

Note: To enhance user experience, occasional software upgrades may occur so that the app interface may vary. Please refer to the actual product.



# 05 CLEANING AND MAINTENANCE

For your cat's health, please clean the cylinder regularly.

## 5.1 Emptying Cat Litter

Before cleaning, please empty the remaining cat litter in the cylinder.

- ① Press the fasteners of the cat litter remover into corresponding holes of the litter sifter. Upon hearing “Click”, the installation is done.

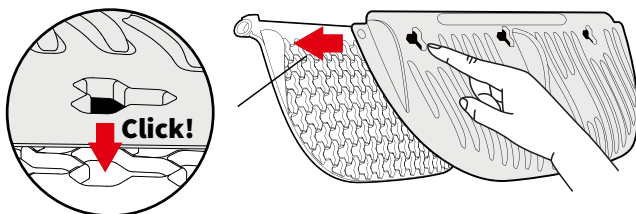

- ② Click “Empty cat litter” on the home page of the device to empty remaining cat litter.



- ③ When emptying the remaining litter is done, pinch A (as shown in the figure) to pull down the remover.

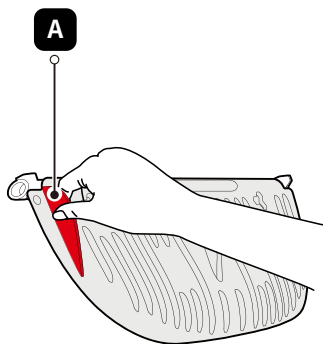

## 5.2 Disassembling Cylinder

① Lift upward to remove the side cover.

**\*Note: Please be sure to turn off or plug off the device before removing the cylinder.**

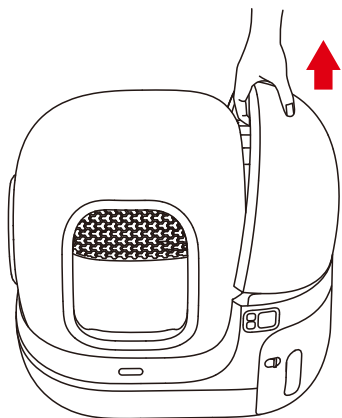

② Disassemble lock components

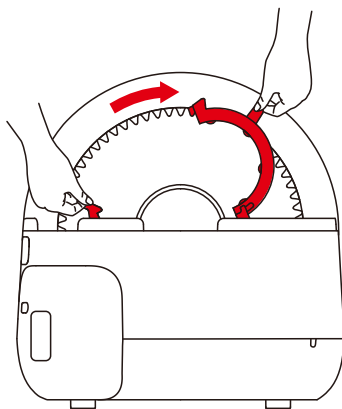

③ Lift upward to take down the cylinder

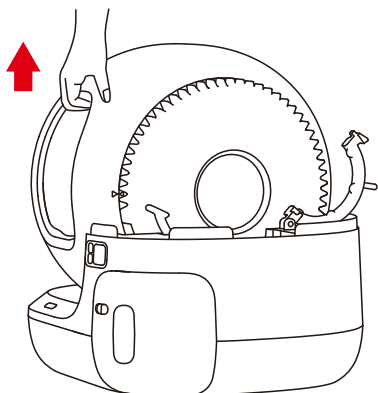

### 5.3 Disassembling Litter Sifter

① Open the side cover and grasp the litter sifter (as shown in Fig. 1) .

**\*Note: Please be sure to turn off or plug off the device before removing the cylinder.**

② Press it inward (as shown in Fig.2) .

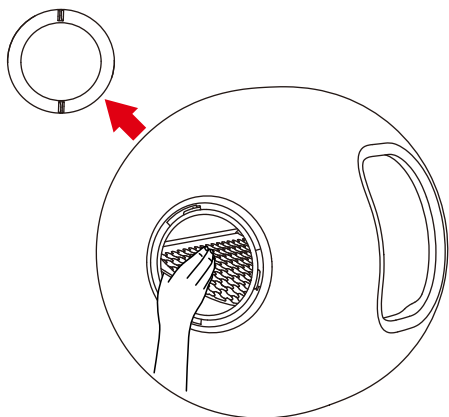

Fig. 1

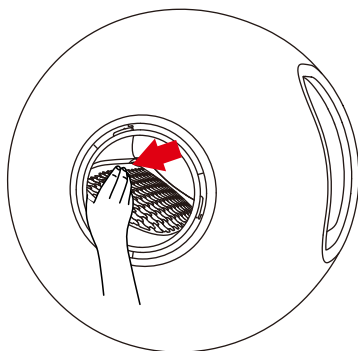
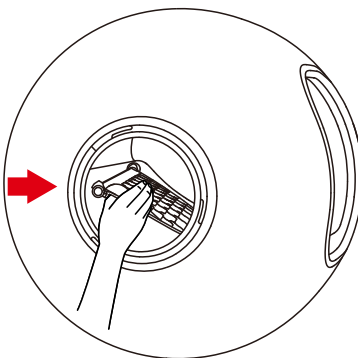
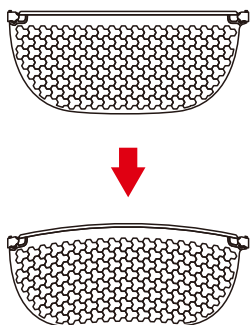

Fig. 2

③ Make the sifter slightly bent and pull it out when it is off the buckle.



## 5.4 Cleaning Main Unit

- ① Wash the cylinder and litter sifter, which is suggested to add moderate amounts of detergent and rinse them thoroughly.
- ② Use a wet towel to wipe the surface and interior of the main unit, ensuring the sensor remains clean.

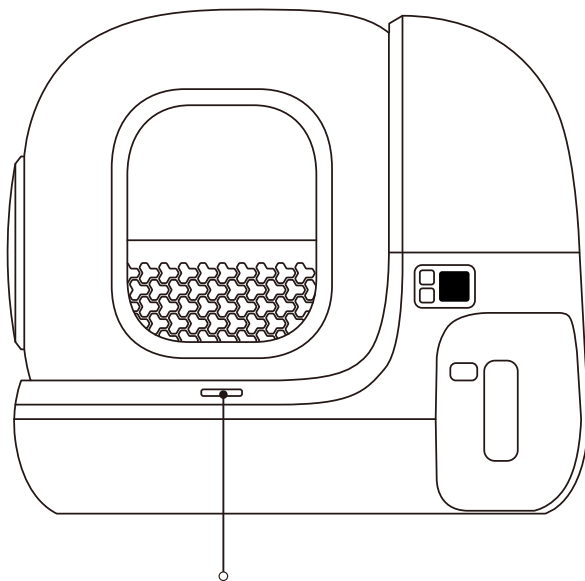

**Proximity Sensor**



**\*Note: After cleaning, all parts should be reassembled only when they are completely dry. The main unit should only be wiped clean. It is prohibited to rinse or immerse it in water, or it may be damaged!**

## 5.5 Installing Litter Sifter

① Secure the front side of the litter sifter into point a.

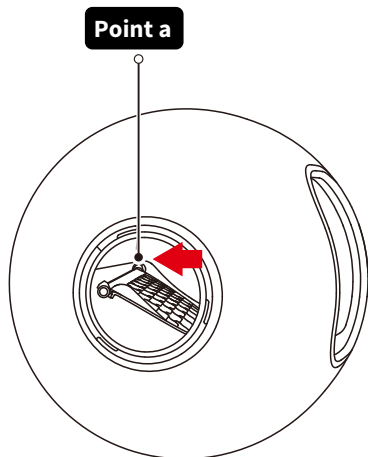

② Grasp the litter sifter and press it inward until it is slightly bent.

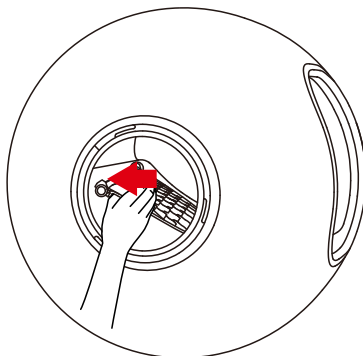

③ Secure the other side of the litter sifter into point b.

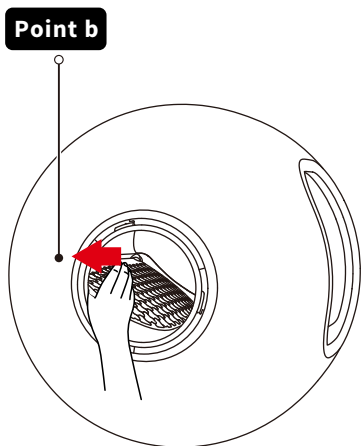

④ If the litter screen is able to be shaken back and forth, the installation is complete.

## 5.6 Installing Cylinder

① Re-install the cylinder

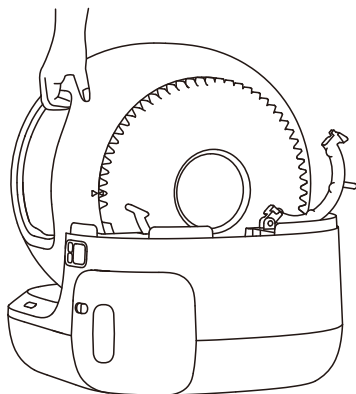

② Secure the buckles of the cylinder and make sure they are firmly fastened.

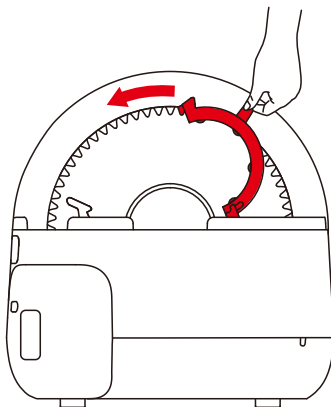

③ Screw the side cover and re-install the magnetic side cover.

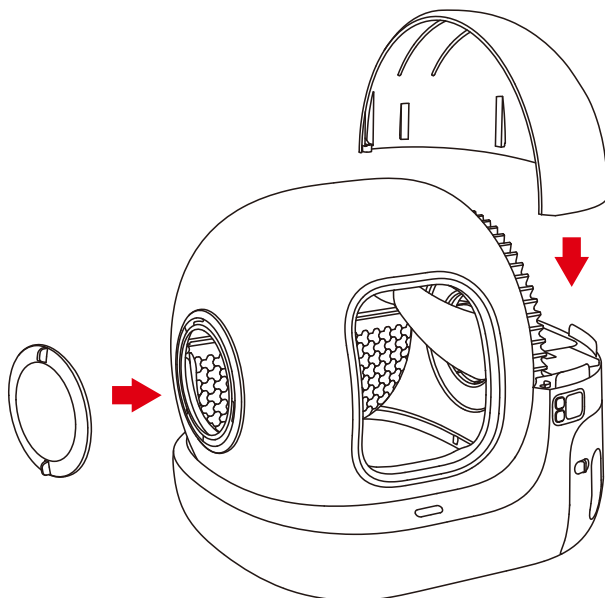

# 06 VIDEO GUIDE

## 6.1 Installation & Usage Video

Please copy the video URL and open it in your browser to view the video.

<https://youtu.be/2aP5PqltmZc>

## 6.2 Maintenance & Cleaning Video

Please copy the video URL and open it in your browser to view the video.

<https://youtu.be/r9Hg3WPaqkg>

## 6.3 Installation & Usage Video for PETKIT AIR PURIFIER SMART SPRAY

Please copy the video URL and open it in your browser to view the video.

<https://youtu.be/Pce7ExQcWhU>

# 07 BASIC SPECIFICATIONS

Product Name	PETKIT PURA MAX SELF-CLEANING CAT LITTER BOX
Product Model	P9902
Product Dimensions	24.4*21.2*21.7in (620*538*552mm)
Overall Weight	About 9.5kg (20.94lb) (including adaptor)
Rated Voltage	12V ===
Rated Power	24W
Connection	Wi-Fi
Application	Cats of 6 months age and above

# 08 A MESSAGE TO OUR VALUED CUSTOMERS

- Thank you for choosing the PETKIT PURA MAX SELF-CLEANING CAT LITTER BOX.
- Please read the User Manual carefully before installing and using the product. Any installation and usage indicates that you have carefully read and accepted the User Safety Guide below.
- PETKIT is not responsible for and legally liable for any accidents or injuries resulting from improper use of the product.
- PETKIT reserves the rights of interpretation and revision.



# 09 USER SAFETY GUIDE

**\*Failure to follow the safety guides outlined below can result in product malfunction or other unforeseen losses.**

- Please install and use the product as instructed in the User Manual.
- Kittens under six months of age and cats weighing less than 1.5kg are not recommended to use this product.
- Do not expose the product to high temperature and humidity.
- The product is for indoor use only. Avoid direct sunlight exposure and keep it away from open flames.
- Although the device uses low voltages, the power cord being chewed by pets can cause electrical leakage. Please ensure proper guidance for your pets to use the product.
- Use only the original adapter to avoid device damage or safety hazards.
- Place the device on a level surface and prevent it from touching wall.
- Do not lean the device against something else to avoid safety hazards.
- Do not immerse or soak the main unit bottom of the product in water.
- Lift and place the product gently when handling to protect the weight sensor at its bottom.
- If you are not using or moving the product for an extended period, it is recommended to unplug.
- Children should use this product under the supervision and guidance of adults.
- Repairs should only be performed with professionals' guidance to avoid accidental damage.
- It is prohibited to place objects on the top of the device or press its top to prevent the device from operating improperly.
- Before leaving for an extended period, ensure sufficient cat litter in the box and space in the waste container.
- If you encounter any issues with the product, please contact our customer service for assistance.

## Disposal

The European directive 2012 / 19 / CE on Waste Electrical and Electronic Equipment(WEEE), requires that old household electrical appliances must not be disposed in the normal unsorted municipal waste stream. Old appliances must be collected separately in order to optimize the recovery and recycling of the materials they contain and reduce the impact on human health and the environment. The crossed out "wheeled bin" symbol on the product reminds you of your obligation, that when you dispose of the appliance it must be separately collected. Consumers should contact their local authority or retailer for information concerning the correct disposal of their old appliance.

This device complies with part 15 of the FCC Rules. Operation is subject to the following two conditions:

- (1) This device may not cause harmful interference, and ;
- (2) this device must accept any interference received, including interference that may cause undesired operation.

### FCC warning:

Any Changes or modifications not expressly approved by the party responsible for compliance could void the user's authority to operate the equipment. Note: This equipment has been tested and found to comply with the limits for a Class B digital device, pursuant to part 15 of the FCC Rules. These limits are designed to provide reasonable protection against harmful interference in a residential installation. This equipment generates uses and can radiate radio frequency energy and, if not installed and used in accordance with the instructions, may cause harmful interference to radio communications. However, there is no guarantee that interference will not occur in a particular installation. If this equipment does cause harmful interference to radio or television reception, which can be determined by turning the equipment off and on, the user is encouraged to try to correct the interference by one or more of the following measures:

- Reorient or relocate the receiving antenna.
- Increase the separation between the equipment and receiver.
- Connect the equipment into an outlet on a circuit different from that to which the receiver is connected.
- Consult the dealer or an experienced radio/TV technician for help.

The device has been evaluated to meet general RF exposure requirement.

This equipment complies with FCC radiation exposure limits set forth for an uncontrolled environment. This equipment should be installed and operated with minimum distance 20cm between the radiator & your body.

### IC warning

#### - English:

This device complies with Industry Canada licence-exempt RSS standard(s). Operation is subject to the following two conditions:

- (1) This device may not cause interference, and
- (2) This device must accept any interference, including interference that may cause undesired operation of the device.

#### - French:

Le présent appareil est conforme aux CNR d'Industrie Canada applicables aux appareils radio exempts de licence.

L'exploitation est autorisée aux deux conditions suivantes:

- (1) l'appareil ne doit pas produire de brouillage, et
- (2) l'utilisateur de l'appareil doit accepter tout brouillage radioélectrique subi, même si le brouillage est susceptible d'en compromettre le fonctionnement.