

PETKIT™

USER MANUAL

PETKIT PURA MAX 2 SELF-CLEANING CAT LITTER BOX

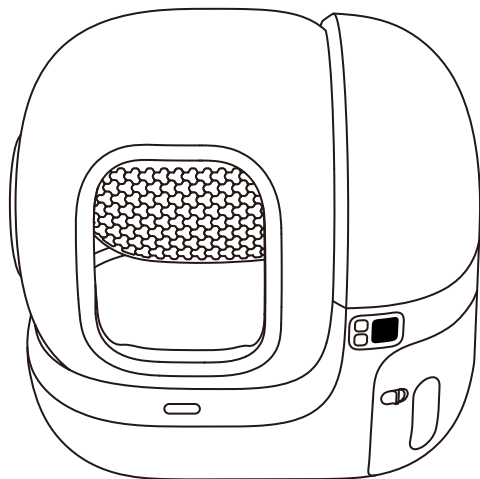

- * The user manual applies to both the basic package and the premium package.
- * Please read through this user manual before using the product and keep it properly.

TABLE OF CONTENTS

PACKAGE LIST	3
PRODUCT DESCRIPTION	4
PRODUCT INSTALLATION	5
HOW TO USE	7
CLEANING AND MAINTENANCE	18
VIDEO GUIDE	26
BASIC SPECIFICATIONS	26
A MESSAGE TO OUR VALUED CUSTOMERS	27
SAFETY GUIDE	27

01 PACKAGE LIST

*Please ensure that all accessories are present before installation and use.

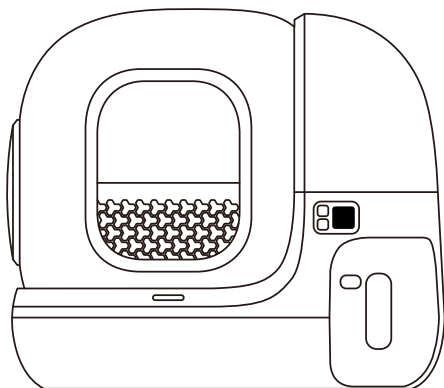

Main Unit

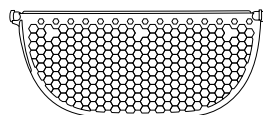

**Honeycomb
Fine Litter Sifter**

* The installation and disassembly method is the same as the standard litter sifter. See 5.2-**1 2** and 5.5-**4 5 6** for details.

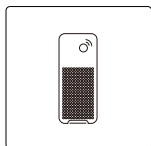

PETKIT Air Purifier Smart Spray

* Only included in the premium package.

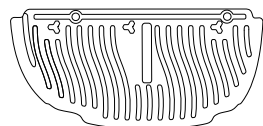

**Magnetic Cat Litter
Remover**

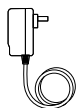

**Power
Adapter**



**Trash
Bag**



**Pet Odor
Eliminator N50 2.0**



**User
Manual**

02 PRODUCT DESCRIPTION

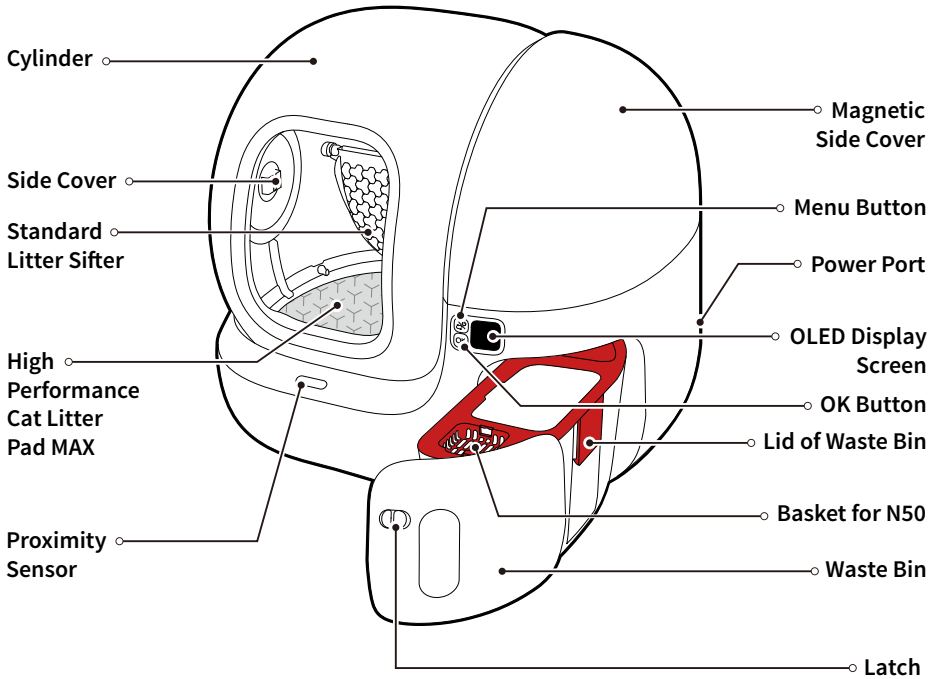

* Note: In order to provide better products, we will regularly improve the product. If the product picture is slightly different from the actual product, the actual product shall prevail.

Introduction of Accessories

Name	Functional Description
Litter Sifter	Effectively filter clumps without clogging or leakage.
High Performance Cat Litter Pad MAX	Anti-stick, scratch-resistant, and easy to clean.
Pet Odor Eliminator N50 2.0	Prevent odor spreading by decomposing odors in the waste bin.

- * Pet odor eliminator N50 2.0 below is referred to as N50.
- * High performance cat litter pad MAX below is referred to as cat litter pad.
- * The standard litter sifter is suitable for tofu cat litter and mixed cat litter;
The honeycomb fine litter sifter is suitable for mineral cat litter.

03 PRODUCT INSTALLATION

❶ Slide the latch to the right and pull out the waste bin. Remove the lid of the waste bin to take out all accessories.

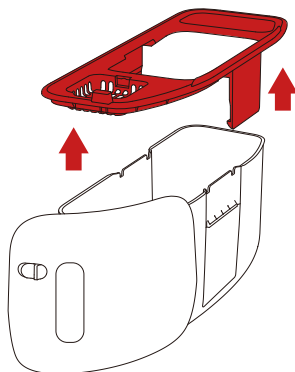
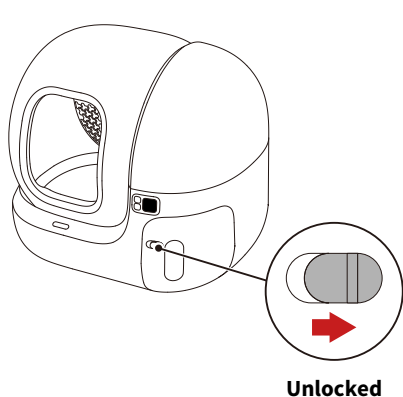

② Install the trash bag in the waste bin, ensuring that the trash bag lies flat at the bottom, then put the lid on.

Note: The two sides of the lid need to clamp the trash bag. (as shown in Fig. 1)

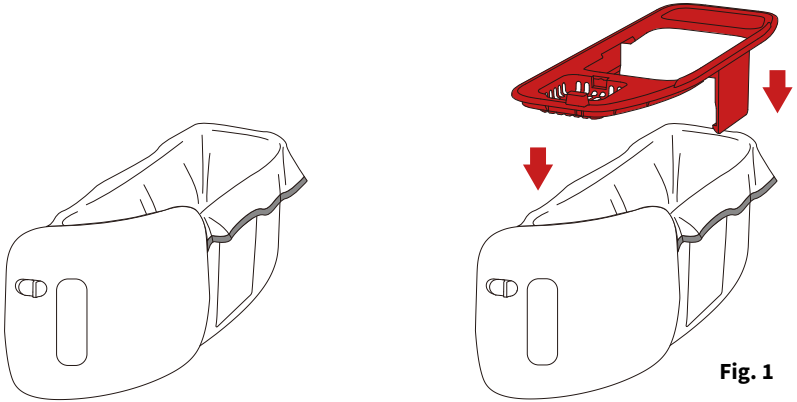
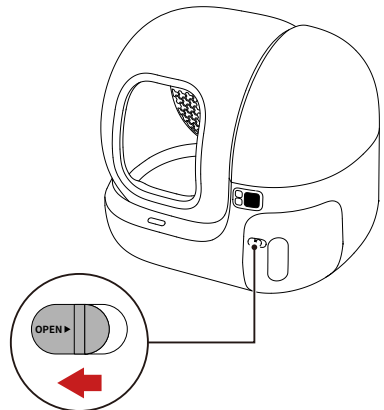
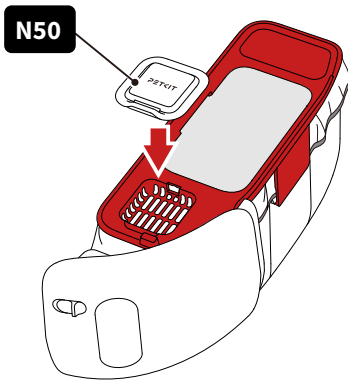

Fig. 1

③ Put the N50 in and press firmly.

④ Install the waste bin back into the main unit and lock the latch.



Locked

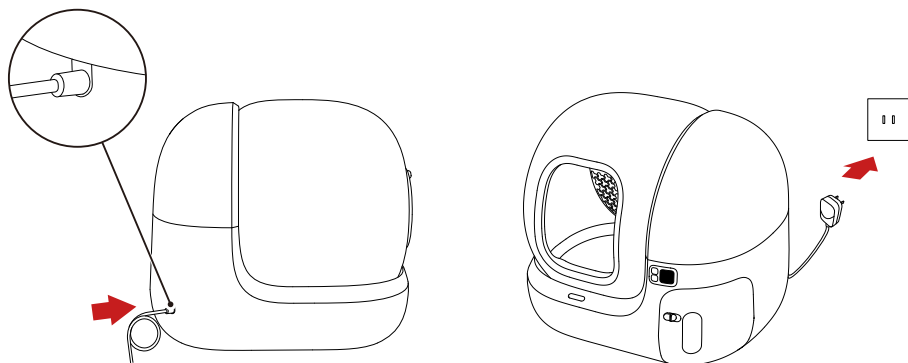

5 Take out the power adapter, insert it into the power port on the back of the main unit, then plug it in.





04 HOW TO USE

4.1 Add Cat Litter

Note: Do not use large particles of cat litter larger than 1.2cm in length and 3mm in diameter.

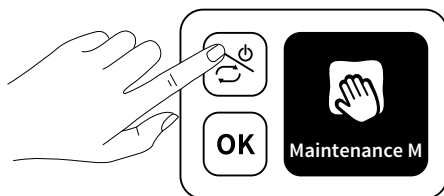
1 After the device is powered on, press the menu button  to switch to “Maintenance Mode” and press the OK button  to execute, and then the cylinder begins to rotate.



② When the cylinder stops with the opening facing up, pour in the cat litter. Press the OK button  to exit “Maintenance Mode”.

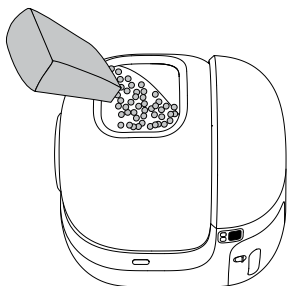

③ Double-press the OK button  and the device will automatically level off the cat litter.





 **Caution: The amount of cat litter doesn't exceed the MAX line of the cat litter pad.**

4.2 Description of Control Panel

① Press the menu button  to switch functions, and press the OK button  to execute.

Long press  Turn on or turn off

Short press  Switch functions, and the screen will show the function.

Short press  Execute the selected function.

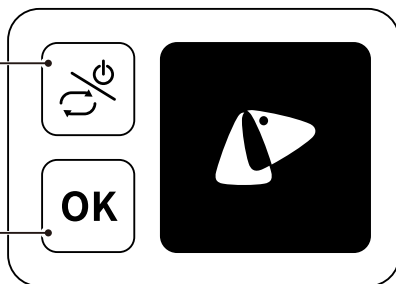

Description of Functions



Maintenance Mode

Use it when adding cat litter or cleaning the device.



Reset

Reset the cylinder to the initial position.



Clean Now

Start automatic scooping.



Configure Network

The device is connecting to the Wi-Fi (use it when binding the app).



Level Cat Litter

Level the cat litter in the cylinder (use it after adding cat litter).



Deodorize

The air purifier begins to deodorize.
* To perform this function, the installation of PETKIT air purifier is required.

2 Displayed Status Description

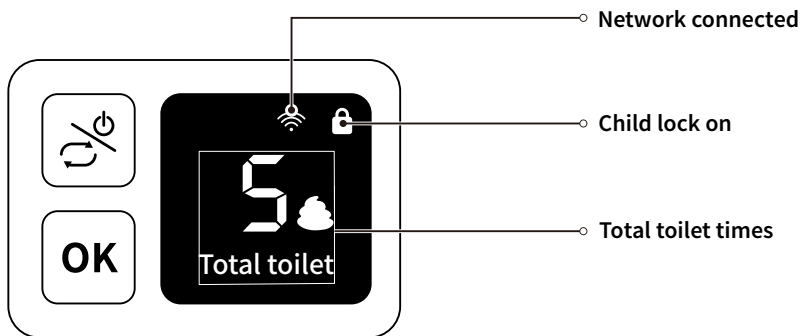

3 Other Prompts Description

There will be scrolling text at the bottom of the screen.

Prompts	Description
 <p>The cat has approached the detection zone</p>	<p>The cat enters while the device is in operation (the device will automatically pause and alert).</p>
 <p>Insufficient cat litter, please add more</p>	<p>The cat litter is insufficient. Please add it in time.</p>
 <p>Device failure</p>	<p>Device failure, please check the details in the app.</p>
 <p>Waste collection bin is full, please empty</p>	<p>The waste bin is full. Please clean it in time.</p>
 <p>Upper cover not closed!</p>	<p>The magnetic side cover is not closed. Please check if it is installed properly.</p>

4.3 Device Binding

❶ Download and install the PETKIT App

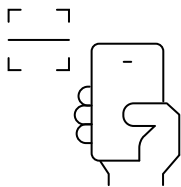

Download the PETKIT App from the App Store or Google Play.

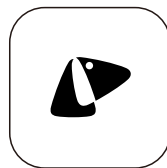

❷ Add the device

Open the app, click “+” in the top right corner and choose “PETKIT PURA MAX 2 SELF-CLEANING CAT LITTER BOX”.

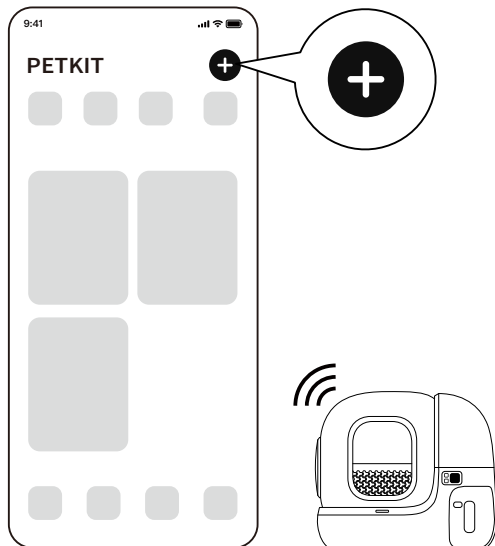

Note: The actual app interface may differ from the image shown due to continuous software upgrades; the actual interface shall prevail.

3 Start connection

Press the menu button on the device to switch to “Configure network”, then press the OK button to execute this function. The screen will display “Connecting...”, and the app will start connecting to the device. Please wait until the configuration is successful.

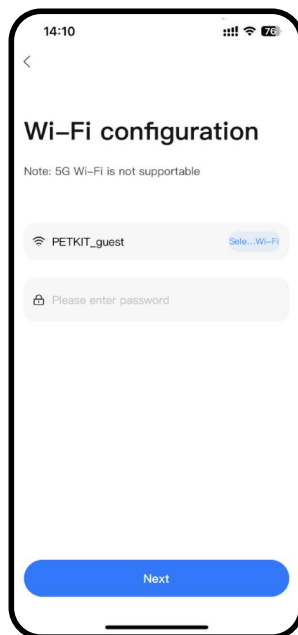
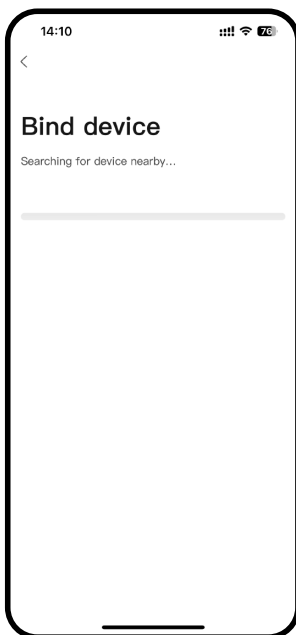

Note: The actual app interface may differ from the image shown due to continuous software upgrades; the actual interface shall prevail.

④ Read instructions

To ensure your pet's safety and use this product properly, please read the instructions carefully after connecting to the app for the first time.

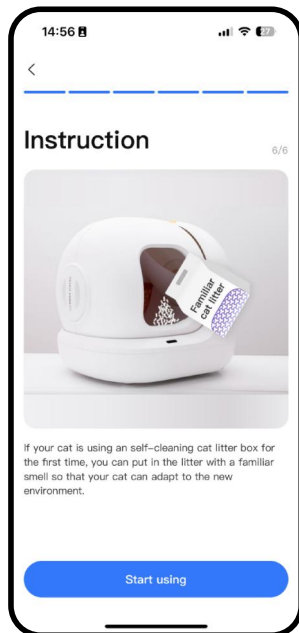
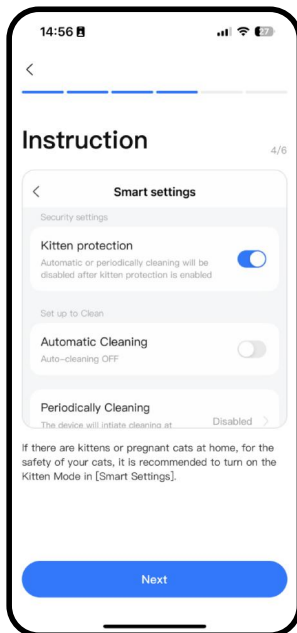
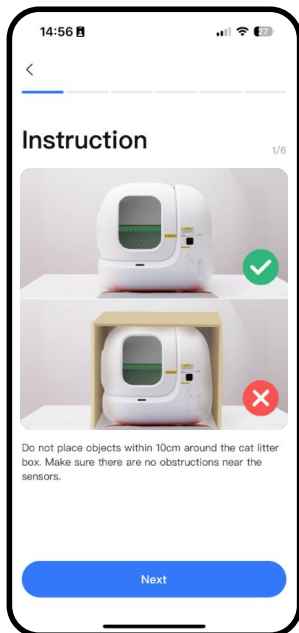

Note: The actual app interface may differ from the image shown due to continuous software upgrades; the actual interface shall prevail.

4.4 Smart App Control

① Check device's status

Enter the device's home page and check its working status, pet toilet times, waste bin status, etc.

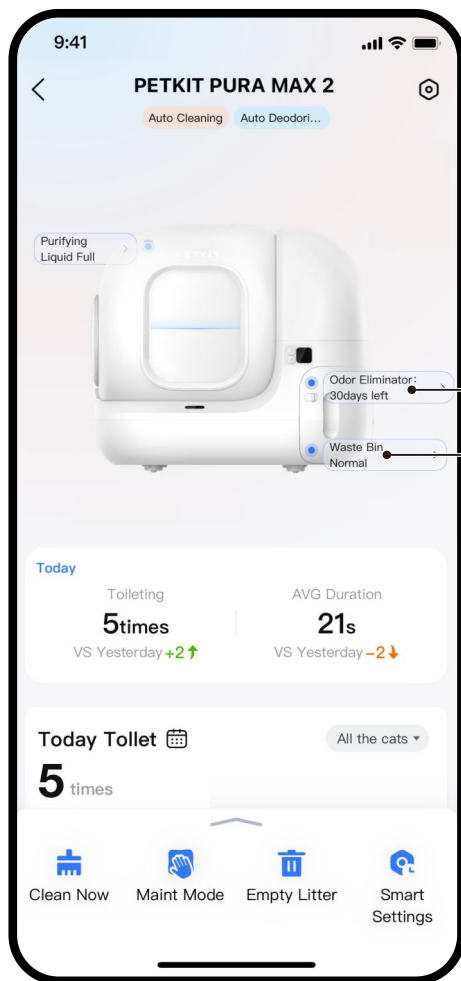

Reminder of the
odor eliminator's
service life

Reminder of
waste bin status

Note: The actual app interface may differ from the image shown due to continuous software upgrades; the actual interface shall prevail.

② Basic functional description



Clean now: Click it to clean the cat litter.



Maintenance mode: Click it and the cylinder will rotate until its opening faces up, making it convenient to add cat litter or clean the device.



Empty cat litter: After installing the magnetic cat litter remover, click it to empty the remaining cat litter in the cylinder.



Smart settings: Set up cleaning mode and safety mode.



Deodorize: Click it to deodorize.

*** To perform this function, it is required to install PETKIT AIR PURIFIER SMART SPRAY.**



Light on: Click it to turn on the light in order to check the internal condition of the cylinder.

*** To perform this function, it is required to install PETKIT AIR PURIFIER SMART SPRAY.**

4.5 How to use PETKIT AIR PURIFIER SMART SPRAY

Click “Binding AIR PURIFIER” on the device’s home page.

- 1 Deodorize:** After the pet leaves the litter box, the AIR PURIFIER will automatically spray to keep air fresh.
- 2 Light on:** Turn on the light in the app to check the internal condition of the cylinder.

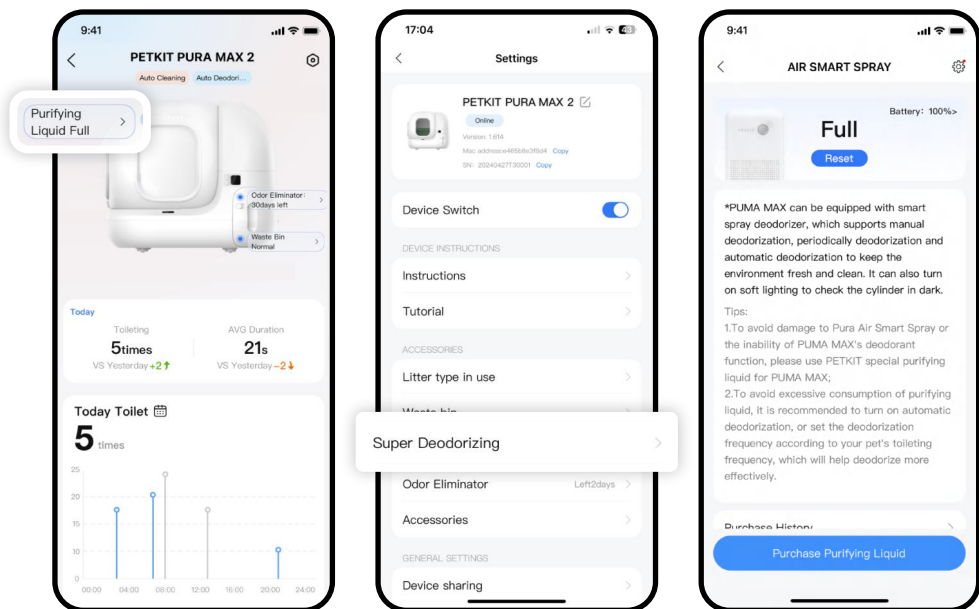

Note: The actual app interface may differ from the image shown due to continuous software upgrades; the actual interface shall prevail.

4.6 Other functions

① Kitten Mode

Turn on this mode if you have kittens or pregnant cats at home. When this mode is on, auto-cleaning and periodical cleaning will be disabled. You can click “Clean now” to clean the cat litter.

Kitten protection

Automatic or periodically cleaning will be disabled after kitten protection is enabled



② Continuous Rotation

When this function is turned on, the device will not stop working even if it detects a cat approaching, which can reduce the possibility of a cat entering and its secretions leaking into the bottom of the device.

*** When this function is turned off, the device will stop working if it detects a cat approaching. If the cylinder opening is facing downwards at the moment, there is a possibility of a cat entering and the leakage of toilet secretions into the bottom of the device, making it hard to clean.**

Continuous rotation

The cylinder does not stop as it rotates from its initial position



Note: The actual app interface may differ from the image shown due to continuous software upgrades; the actual interface shall prevail.

05 CLEANING AND MAINTENANCE

For the cat's health, it is suggested to regularly clean and replace these parts.

⚠ Caution: Before operation, please make sure the device is powered off.

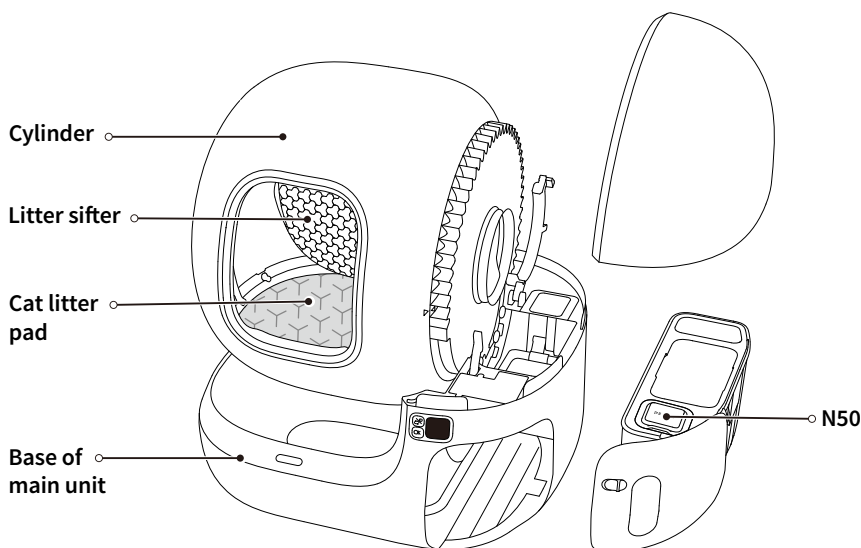

Name of Parts	When to Clean	How to Clean	When to Replace	How to Disassemble
Cylinder	When the inner surface is dirty.	Clean it with a brush and dry it.	/	Refer to 5.3
Litter Sifter	Clean it in time when pets have loose stools.	Clean it with a brush and dry it.	When it is bent and damaged.	Refer to 5.2
Cat Litter Pad	When it is dirty.	Wipe with a soft cloth or paper towel and clean water. Do not scrub.*	When it sticks to the cat litter severely or is broken.	Refer to 5.2
Base of Main Unit	After disassembling the cylinder.	Wipe with a damp paper towel.	/	/
Proximity Sensor	When the surface of the sensor is dirty.	Wipe with a soft cloth.	/	/
N50	/	/	About one month	Take it out

* Avoid cleaning with alcohol, disinfectant, bleach, non-neutral detergent, etc.

5.1 Empty Cat litter Before Cleaning

❶ Pinch the raised part in the middle of the magnetic cat litter remover and align the three grooves on it with the corresponding holes on the litter sifter. Once you hear a "click" sound, the installation is successful.

❷ Click "Empty litter" on the app, and then empty the cat litter in the cylinder according to the guide.

❸ After use, pinch the raised part on the left and pull out the magnetic cat litter remover.

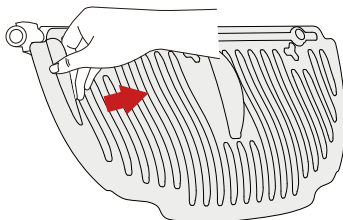
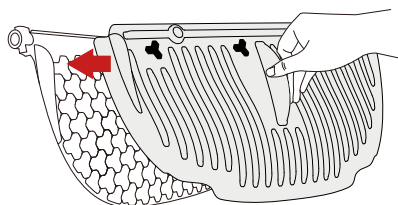

5.2 Disassemble Litter Sifter and Cat Litter Pad

❶ Rotate counterclockwise to remove the side cover.

❷ Press the middle of the litter sifter until it is bent and separates from the left buckle, then remove the litter sifter.

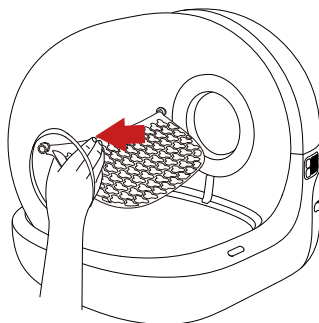
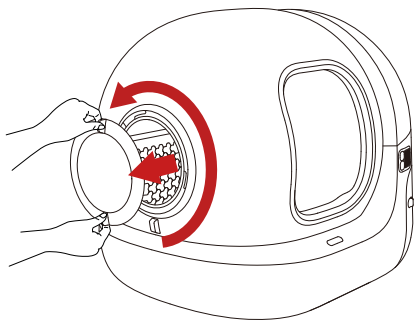

③ Pinch the handle of the cat litter pad to pull out the cat litter pad.

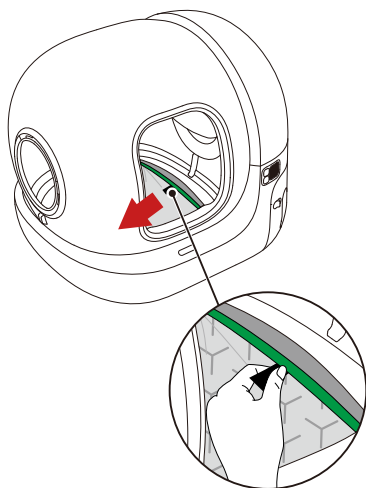

5.3 Disassemble Cylinder

① Remove the magnetic side cover upward.

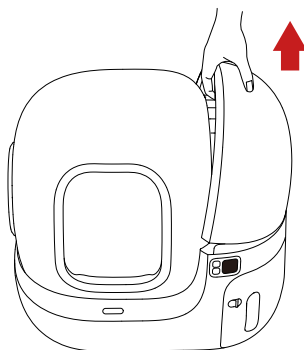

② Unlock the buckle.

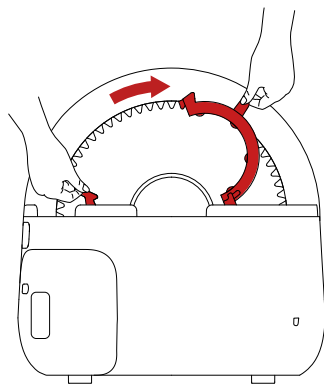

③ Remove the cylinder upward.

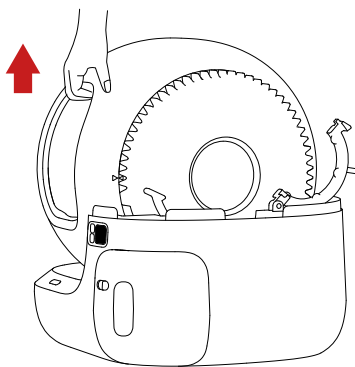

5.4 Clean All Parts

⚠ Caution: The main unit is strictly prohibited from rinsing and soaking. It can only be wiped, otherwise, the device will be damaged.

❶ Clean every corner of the cylinder with a brush and rinse it.

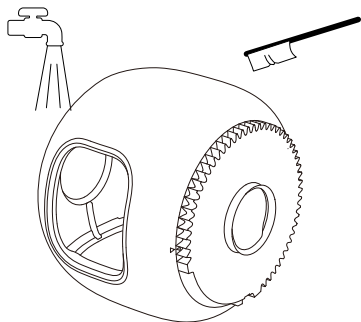

❷ Scrub the litter sifter with a brush and rinse it off. Wipe the cat litter pad with a wet cloth.

Caution: Do not scrub vigorously to avoid damaging the coating of the cat litter pad. Avoid cleaning with non-neutral detergents such as alcohol, disinfectant, zbleach, etc.

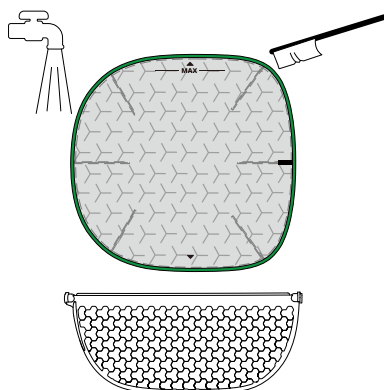

❸ Wipe the base with a damp paper towel to keep the sensor clean.

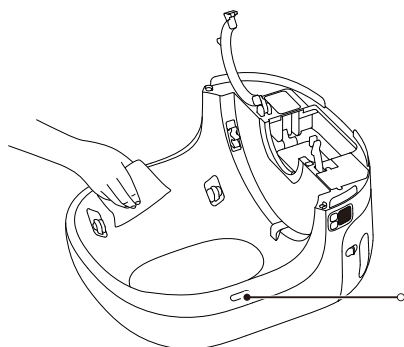

proximity sensor

5.5 Install All Parts

⚠ **Caution:** Install all parts only when they are completely dry.

❶ Put the cylinder on the base, lock the buckle, and make sure the buckle is fastened.

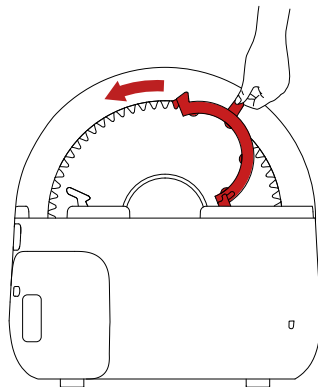
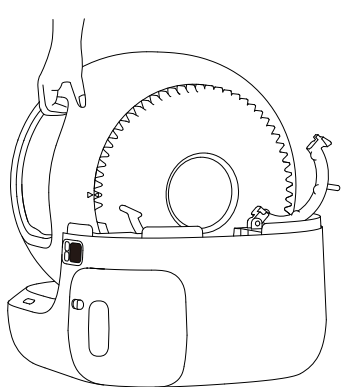

❷ Hold the cat litter pad, insert the upper part of it into the groove, and then insert the bottom of it into the groove (align with the arrows).

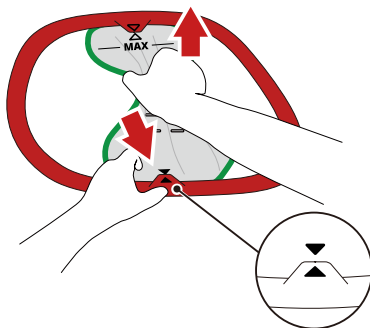
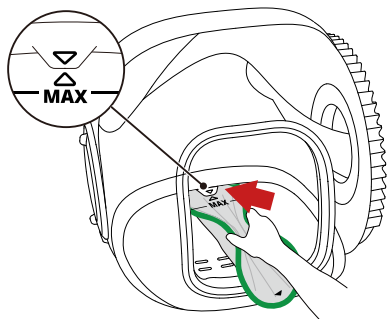

3 Press gently and release the litter pad; its two sides will be automatically inserted into the groove.

Caution: Before use, make sure that the green edge of the cat litter pad is fully stuck into the groove and that the arrows ▲ on both ends are aligned with the direction indicated.

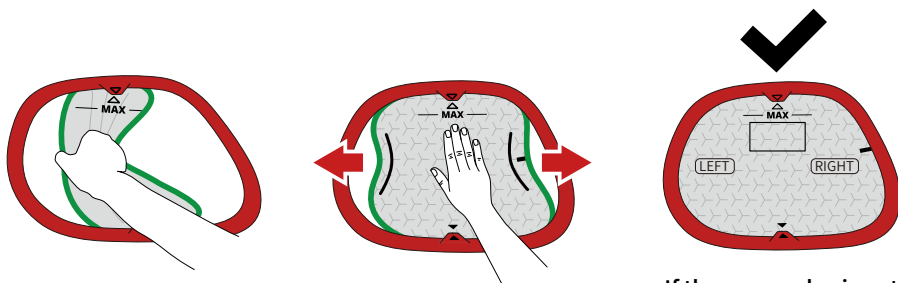

If the green edge is not visible, the installation is successful.

4 Insert one side of the litter sifter into point A in the cylinder.

5 Grasp the litter sifter and press it until it is bent.

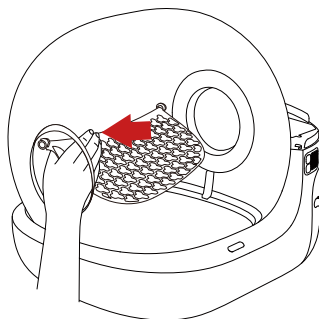
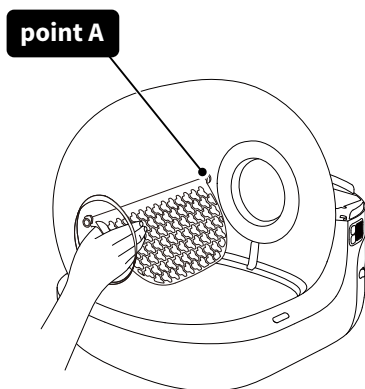

- 6 Insert the other side of the litter sifter into point B in the cylinder.

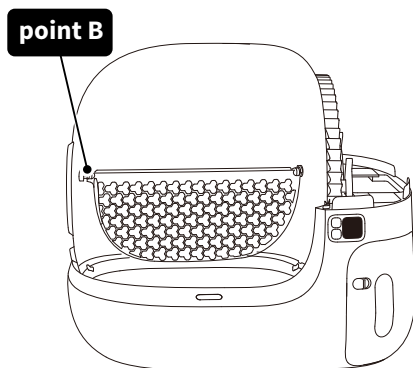

- 7 Please check: If the litter sifter can be shaken back and forth, the installation is successful.

- 8 Install the side cover and rotate it clockwise, then install the magnetic side cover.

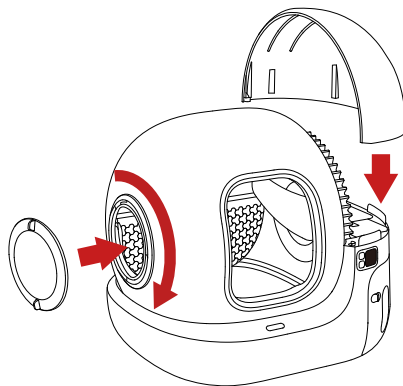

06 VIDEO GUIDE

6.1 Video of Installation and Usage

Please copy the video URL and open it in your browser to view the video.

<https://m.youtube.com/watch?v=1zmqlw2fiho>

6.2 Video of Cleaning and Maintenance

Please copy the video URL and open it in your browser to view the video.

<https://m.youtube.com/watch?v=3hx0biUujkM&feature=youtu.be>

07 BASIC SPECIFICATIONS

Product Name	PETKIT PURA MAX 2 SELF-CLEANING CAT LITTER BOX
Product Model	P9902
Dimensions	620 x 538 x 552 mm (24.41 x 21.18 x 21.73 in)
Weight	about 10 kg (22 lb)
Rated Input	12V === 2A
Connection	Wi-Fi, BLE
Scope of Application	Cats older than 6 months

08 A MESSAGE TO OUR VALUED CUSTOMERS

- Thank you for choosing the PETKIT PURA MAX 2 SELF-CLEANING CAT LITTER BOX.
- Please read the user manual carefully before installing and using the product. Any installation or usage indicates that you have read and accepted the safety guide below.
- PETKIT is not responsible for or legally liable for any accidents or injuries resulting from the improper use of the product.
- PETKIT reserves the right to interpretation and revision.

09 SAFETY GUIDE

*** Failure to follow the safety guides below may result in product malfunction or other unforeseen losses.**

- Please install and use the product according to the user manual.
- Cats younger than six months are not recommended to use this product. Cats weighing less than 1.5 kg are not recommended to use this product.
- Do not place the device in a high-temperature or high-humidity environment.
- The product is for indoor use only. Please avoid direct sunlight exposure and keep it away from the source of flame.
- Although the device is powered by a low voltage, electric leakage may occur if the pet bites the power cord. Please guide your pets to use the product properly.
- Only use the original adapter to avoid device damage or safety hazards.
- Place the device on a hard, flat surface and avoid touching the wall.
- Do not tilt the device to avoid security risks.
- Do not immerse or soak the bottom of the device in water.
- There are weight sensors at the bottom of the device. Please handle it gently.
- Please unplug it if the device is not used for an extended period.
- Children should use this product under the supervision and guidance of adults.
- Repairs should only be performed with professionals' guidance to avoid accidental damage.
- It is prohibited to place objects on the top of the device or press the device's top to avoid affecting the normal operation of the device.
- Before leaving for an extended period, please ensure that there is sufficient cat litter in the litter box and space in the waste drawer.
- If you have any problems with the product, please contact our customer service for assistance.

Disposal

The European directive 2012 / 19 / CE on Waste Electrical and Electronic Equipment(WEEE), requires that old household electrical appliances must not be disposed in the normal unsorted municipal waste stream. Old appliances must be collected separately in order to optimize the recovery and recycling of the materials they contain and reduce the impact on human health and the environment. The crossed out "wheeled bin" symbol on the product reminds you of your obligation, that when you dispose of the appliance it must be separately collected. Consumers should contact their local authority or retailer for information concerning the correct disposal of their old appliance.

This device complies with part 15 of the FCC Rules. Operation is subject to the following two conditions:

- (1) This device may not cause harmful interference, and ;
- (2) this device must accept any interference received, including interference that may cause undesired operation.

FCC warning:

Any Changes or modifications not expressly approved by the party responsible for compliance could void the user's authority to operate the equipment. Note: This equipment has been tested and found to comply with the limits for a Class B digital device, pursuant to part 15 of the FCC Rules. These limits are designed to provide reasonable protection against harmful interference in a residential installation. This equipment generates uses and can radiate radio frequency energy and, if not installed and used in accordance with the instructions, may cause harmful interference to radio communications. However, there is no guarantee that interference will not occur in a particular installation. If this equipment does cause harmful interference to radio or television reception, which can be determined by turning the equipment off and on, the user is encouraged to try to correct the interference by one or more of the following measures:

- Reorient or relocate the receiving antenna.
- Increase the separation between the equipment and receiver.
- Connect the equipment into an outlet on a circuit different from that to which the receiver is connected.
- Consult the dealer or an experienced radio/TV technician for help.

The device has been evaluated to meet general RF exposure requirement.

This equipment complies with FCC radiation exposure limits set forth for an uncontrolled environment. This equipment should be installed and operated with minimum distance 20cm between the radiator & your body.

IC warning

- English:

This device complies with Industry Canada licence-exempt RSS standard(s). Operation is subject to the following two conditions:

- (1) This device may not cause interference, and
- (2) This device must accept any interference, including interference that may cause undesired operation of the device.

- French:

Le présent appareil est conforme aux CNR d'Industrie Canada applicables aux appareils radio exempts de licence.

L'exploitation est autorisée aux deux conditions suivantes:

- (1) l'appareil ne doit pas produire de brouillage, et
- (2) l'utilisateur de l'appareil doit accepter tout brouillage radioélectrique subi, même si le brouillage est susceptible d'en compromettre le fonctionnement.

